

# 54670 ESU PowerPack

## Instruction manual

4. Edition, June 2015

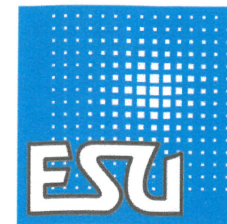
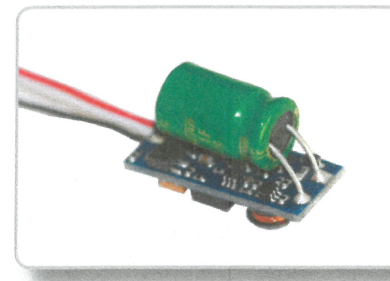

### 1. Declaration of Conformity

We, ESU electronic solutions ulm GmbH & Co. KG, Edisonallee 29, D-89231 Neu-Ulm, Germany, declare in sole responsibility that the product

**Product description: PowerPack**

**Part number: 54670**

complies with all relevant regulations of the Directive for Electromagnetic Compatibility (2004/108/EG). The following harmonised standards have been applied:

EN 55014-1:2006 + A1:2009: Electromagnetic Compatibility - requirements for household appliances, electric tools, and similar apparatus - Part 1: Emission - Product

EN 55014-2:1997 + A1:2001 + A2:2008: Electromagnetic Compatibility - Requirements for household appliances, electric tools, and similar apparatus - Part 2: Immunity - Product family standard.

### 2. WEEE-Declaration

Disposal of obsolete electrical and electronic equipment (as practised in the European Union and other European countries with dedicated collection systems).



This mark on the product, the packaging or the relevant documentation indicates that this product must not be treated like household waste. Instead this product should be disposed of at a suitable collection point for recycling of electrical and electronic appliances. Thus you contribute to avoid negative impact on the environment and people's health that could be caused by inappropriate disposal. Recycling of materials contributes to preserve our natural resources. For more information regarding recycling of this product, please contact your local administration, your waste collection service or the dealer / shop where you purchased this product.

### 6. CV-Settings

The bypass time can be adjusted by means of CV 113. The standard value of 50 results in approx. 0.8 seconds. If you operate block sections, with which a signal stop is caused by switching the operating voltage off, and would like the delayed shut off time to be reduced in order to grant a point-exact deceleration. Reduce the value in CV 113.

Values smaller than 10 should be avoided, otherwise the effect of the PowerPack is hardly measurable.



If you stop the engine for a very long time, it can occur that the energy stored in the PowerPack is not sufficient. In this case the decoder, before reaching the adjusted time, will naturally switch off.

The attainable stored energy depends strongly on the current consumption and can reach up to 3 seconds. The Maximum Value of CV113 is 255. A recommended value of 150 will give about 2.45 sec of stored energy, and will charge properly on most layouts.

### 7. Analogue operation

The PowerPack automatically switches off when operated on an analog DC or AC layout. In such a case, the buffer function is unfortunately not possible due to technical reasons.

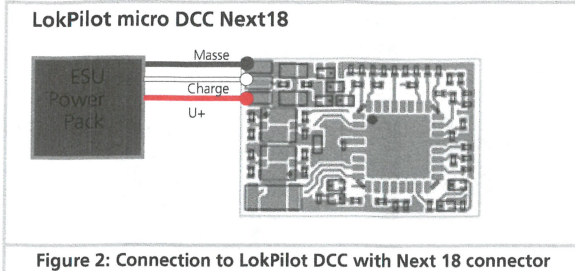
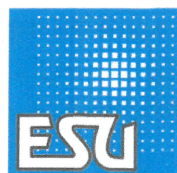

Figure 2: Connection to LokPilot DCC with Next 18 connector

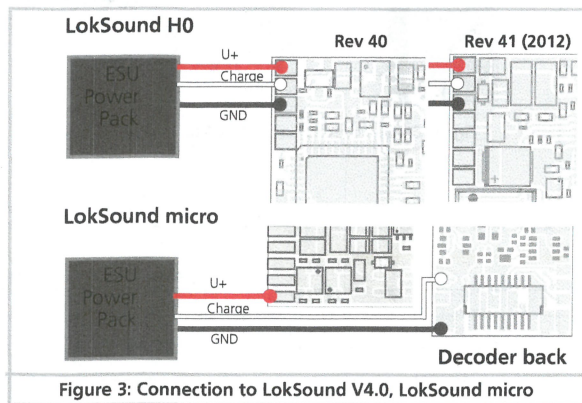

Figure 3: Connection to LokSound V4.0, LokSound micro

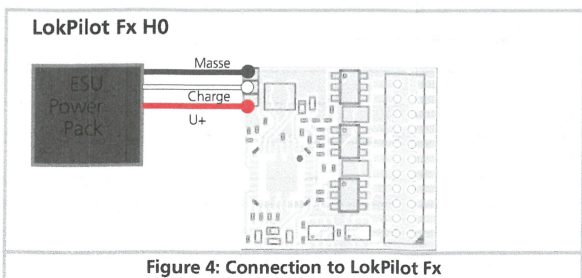



Figure 4: Connection to LokPilot Fx

## Important notes & General characteristics

### 3. Important notes – PLEASE READ FIRST

We congratulate you on the acquisition of the ESU power pack. This guide will take you step by step through the connection of the module to an ESU decoder. Please read this guide carefully before start-up.

Although the PowerPack is very sturdily developed, a wrong connection could lead to the destruction of the module. If in doubt, please refrain from any “expensive” experiments.

 The PowerPack is exclusively intended for the application with model railway electric trains. It may be operated only with the components described in this guide. Any other use as described in this manual is not permitted.

- All connection work may be accomplished only during switched off operating voltage.
- Please always stick to the suggested principles of this user manual when connecting the main board.
- Avoid impact and pressure loads on the PowerPack as well as the selected ESU decoder.
- Protect against wet conditions and humidity.
- Do not let bare wires touch metal parts of the locomotive.
- Make sure when assembling the locomotive that no cables are squeezed or short-circuits will develop.

### 4. General characteristics

The ESU PowerPack can be attached optionally to all LokPilot V4.0 or LokSound V4.0 and LokSound Select decoders and supplies your locomotive with reliable energy when running over dirty track and long switches. The sound, the lights and engine functions are buffered so the loco can continue running up to 3 seconds after it loses power. (Actual time will vary depending on certain conditions). When operated on analogue layouts, the PowerPack will be automatically switched off.

The PowerPack possesses an integrated charging circuit controlled by the decoder. It can remain in the locomotive even during programming. The charging current is limited, in order to prevent an excessive load on the boosters if several models are in use. The buffering time can be restricted via the decoder with CV113, and thus red signals will lead to an exact stop in front of the signal. The PowerPack measures ca. 22 x 10 x 14mm.

### 5. Connection to the decoder

The PowerPack comes with loose connection wires. The module itself is wrapped in heat shrink plastic to protect the fragile components as well as simplify the installation into the locomotive. Please leave heat shrink intact during assembly, as it prevents possible short-circuits to metal parts within the locomotive.

All LokSound and LokPilot decoders of the 4th generation series can be connected to the PowerPack, such as LokPilot, LokPilot micro, LokSound, LokSound micro or LokSound Select, LokSound Select Micro and LokSound Select Direct.

All decoders have soldering pads on which the PowerPack’s wires need to be soldered.

The respective manuals of the ESU decoders described show the typical soldering locations.

Refer to Figure 1 for the most common wiring diagram.

In order to be able to reach the soldering surfaces, it is permissible to remove the heat shrink sleeve here. Best this happens through cuts opening the corner of the concerned decoder’s heat shrink. Leave the remaining heat shrink sleeve on the decoder.

## Important notes & General characteristics

- Solder the red cable at the soldering surface «U+» on.
- Solder the white cable to the soldering surface «charge»
- Solder that black cables to the soldering surface «GND».

 Absolutely make sure when soldering that you do not manufacture short-circuits between the soldering surfaces or to other construction units on the decoder! If a short-circuit develops you will ruin the decoder!

 The PowerPack will create some heat during operation. Please be sure to leave room around the PowerPack for ventilation.

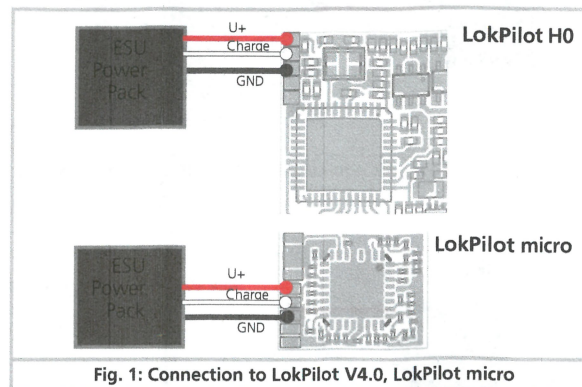

### Trouble shooting sheet

#### 1. Personal data (Please write in block letters)

Name: .....

Street: .....

ZIP / City: .....

Country: .....

Email: .....

Phone: .....

Date: .....

Signature: .....

#### 3. Error description (use extra page if needed)

.....

.....

#### 4. Receipt - Proof of purchase

Please enclose your receipt / invoice.  
Otherwise no warranty possible!

#### 6. Your retailer

.....

.....

Retailer's stamp or address

